

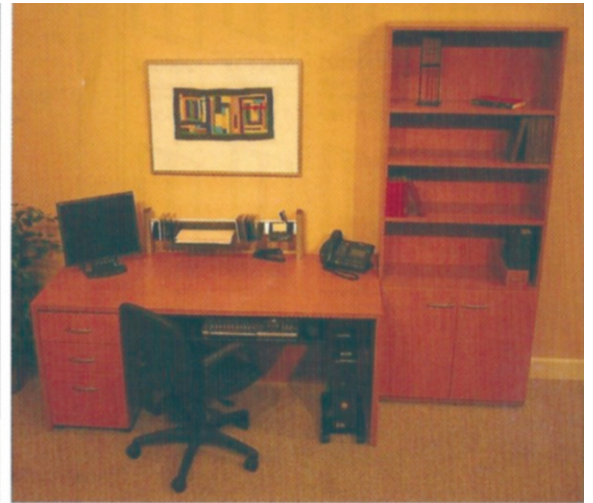





TQS techline
Quick Ship



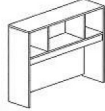

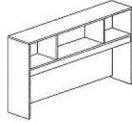







Series 2



HUTCHES















| | | | | |
|---|---|---|---|--|
|  <p>200460 32"W 36 1/8"H 13 1/8"D Hutch</p> |  <p>200460 48"W 36 7/8"H 13 1/8"D Hutch</p> |  <p>200460 60"W 36 7/8"H 13 1/8"D Hutch</p> |  <p>200460 66"W 36 7/8"H 13 1/8"D Hutch</p> |  <p>200162 Form Holder Cabinet</p> <p>(W) 32 (H) 13 3/4 (D) 13 1/8</p> |
|---|---|---|---|--|

WALL CABINETS

| | | | | | |
|---|--|--|--|---|--|
|  <p>(W) 16 (H) 26 (D) 13 1/8</p> <p>200320 Wall Cabinet - Open</p> |  <p>(W) 20 (H) 26 (D) 13 1/8</p> <p>200321 Wall Cabinet - Open</p> |  <p>(W) 24 (H) 26 (D) 13 1/8</p> <p>200322 Wall Cabinet - Open</p> |  <p>(W) 32 (H) 26 (D) 13 1/8</p> <p>200323 Wall Cabinet - Open</p> |  <p>(W) 32 (H) 26 (D) 32</p> <p>200122 Inside Corner Cabinet</p> |  <p>(W) 32 (H) 26 (D) 14</p> <p>200355 Form Holder Cabinet - Double Door</p> |
|  <p>(W) 16 (H) 38 1/2 (D) 13 1/8</p> <p>200320 Wall Cabinet - Open</p> |  <p>(W) 20 (H) 38 1/2 (D) 13 1/8</p> <p>200321 Wall Cabinet - Open</p> |  <p>(W) 24 (H) 38 1/2 (D) 13 1/8</p> <p>200322 Wall Cabinet - Open</p> |  <p>(W) 32 (H) 38 1/2 (D) 13 1/8</p> <p>200323 Wall Cabinet - Open</p> |  <p>(W) 32 (H) 38 1/2 (D) 32</p> <p>200122 Inside Corner Cabinet</p> |  <p>(W) 32 (H) 38 1/2 (D) 14</p> <p>200355 Form Holder Cabinet - Double Door</p> |









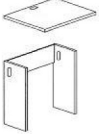
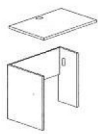

PEDESTAL AND LATERAL FILES

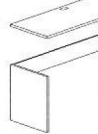
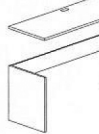
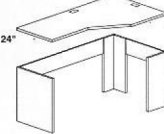
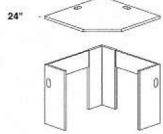
Lateral files equipped with anti-tilt mechanism.







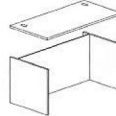
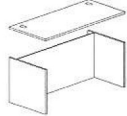

| | | | | | | |
|---|--|--|--|--|---|--|
|  <p>(W) 16 (H) 26 (D) 20 1/4</p> <p>200223 File Cabinet, 12-12</p> |  <p>(W) 16 (H) 26 (D) 24</p> <p>200223 File Cabinet, 12-12</p> |  <p>(W) 16 (H) 26 (D) 20 1/4</p> <p>200230 Drawer File Cabinet, 6-6-12</p> |  <p>(W) 16 (H) 26 (D) 24</p> <p>200230 Drawer File Cabinet, 6-6-12</p> |  <p>(W) 32 (H) 26 (D) 20 1/4</p> <p>200225 Lateral File Cabinet, 12-12</p> |  <p>(W) 32 (H) 38 1/2 (D) 20 1/4</p> <p>200248 Lateral File Cabinet, 12-12-12</p> |  <p>(W) 32 (H) 51 1/4 (D) 20 1/4</p> <p>200250 Lateral File Cabinet, 12-12-12-12</p> |
|  <p>(W) 16 (H) 2 (D) 19 1/2</p> <p>200900 Cabinet Base</p> |  <p>(W) 16 (H) 2 (D) 23 1/4</p> <p>200900 Cabinet Base</p> |  <p>(W) 16 (H) 2 (D) 19 1/2</p> <p>200900 Cabinet Base</p> |  <p>(W) 16 (H) 2 (D) 23 1/4</p> <p>200900 Cabinet Base</p> |  <p>(W) 32 (H) 2 (D) 19 1/2</p> <p>200900 Cabinet Base</p> |  <p>(W) 32 (H) 2 (D) 19 1/2</p> <p>200900 Cabinet Base</p> |  <p>(W) 32 (H) 2 (D) 19 1/2</p> <p>200900 Cabinet Base</p> |

MODULAR DESKING

End bases are configurable both left and right.

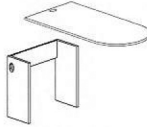
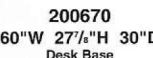
| | | | | | | |
|---|---|---|---|--|---|--|
|  <p>200600 30"W 1 1/8"H 24"D Work Surface - Rectangular</p> |  <p>200600 36"W 1 1/8"H 24"D Work Surface - Rectangular</p> |  <p>200600 48"W 1 1/8"H 24"D Work Surface - Rectangular</p> |  <p>200600 60"W 1 1/8"H 24"D Work Surface - Rectangular</p> |  <p>200600 66"W 1 1/8"H 24"D Work Surface - Rectangular</p> |  <p>200606 66"W 1 1/8"H 36"D Work Surface - Right (shown)</p> |  <p>200610 36"W 1 1/8"H 36"D Work Surface - Corner</p> |
|  <p>200650 30"W 27 7/8"H 12 5/8"D Common Base</p> |  <p>200656 36"W 27 7/8"H 24"D End Base</p> |  <p>200656 48"W 27 7/8"H 24"D End Base</p> |  <p>200656 60"W 27 7/8"H 24"D End Base</p> |  <p>200656 66"W 27 7/8"H 24"D End Base</p> |  <p>200662 66"W 27 7/8"H 36"D Corner Base</p> |  <p>200660 36"W 27 7/8"H 36"D Corner Base</p> |

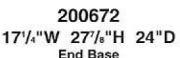
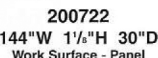

















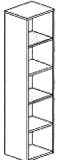
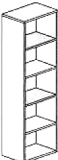
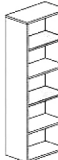

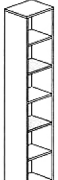





FREESTANDING DESKING

| | | | | | |
|---|---|---|---|--|---|
|  <p>200640 60"W 1 1/8"H 30"D Desk Top - Rectangular</p> |  <p>200640 66"W 1 1/8"H 30"D Desk Top - Rectangular</p> |  <p>200600 Work Surface - Rectangular (W) 30 36 48 (H) 1 1/8 (D) 24</p> |  <p>200680 End Work surface Support (W) 12 1/2 (H) 27 7/8 (D) 1 1/8</p> |  <p>200722 144"W 1 1/8"H 24"D Work Surface - Panel</p> |  <p>200625 66"W 1 1/8"H 30"D Work Surface - Peninsula</p> |
|  <p>200670 60"W 27 7/8"H 30"D Desk Base</p> |  <p>200670 66"W 27 7/8"H 30"D Desk Base</p> |  <p>200672 17 1/4"W 27 7/8"H 24"D End Base</p> | |  <p>200722 144"W 1 1/8"H 30"D Work Surface - Panel</p> |  <p>200655 30"W 27 7/8"H 12 5/8"D Base</p> |

Work Surface - Panel has two long sides edged only. Field-cut to desired width. No drilling or grommet included.













OPEN CABINETS AND BASES

➤ Indicates fixed shelf location

























| | | | |
|---|--|--|--|
|  200100 Open Cabinet (W) 16 (H) 26 (D) 13 1/2 |  200103 Open Cabinet (W) 20 (H) 26 (D) 13 1/2 |  200106 Open Cabinet (W) 24 (H) 26 (D) 13 1/2 |  200109 Open Cabinet (W) 32 (H) 26 (D) 13 1/2 |
|  200100 Open Cabinet (W) 16 (H) 38 1/2 (D) 13 1/2 |  200103 Open Cabinet (W) 20 (H) 38 1/2 (D) 13 1/2 |  200106 Open Cabinet (W) 24 (H) 38 1/2 (D) 13 1/2 |  200109 Open Cabinet (W) 32 (H) 38 1/2 (D) 13 1/2 |
|  200100 Open Cabinet (W) 16 (H) 63 1/2 (D) 13 1/2 |  200103 Open Cabinet (W) 20 (H) 63 1/2 (D) 13 1/2 |  200106 Open Cabinet (W) 24 (H) 63 1/2 (D) 13 1/2 |  200109 Open Cabinet (W) 32 (H) 63 1/2 (D) 13 1/2 |
|  200100 Open Cabinet (W) 16 (H) 76 1/2 (D) 13 1/2 |  200103 Open Cabinet (W) 20 (H) 76 1/2 (D) 13 1/2 |  200106 Open Cabinet (W) 24 (H) 76 1/2 (D) 13 1/2 |  200109 Open Cabinet (W) 32 (H) 76 1/2 (D) 13 1/2 |
|  200900 Cabinet Base (W) 16 (H) 2 (D) 13 1/2 |  200900 Cabinet Base (W) 20 (H) 2 (D) 13 1/2 |  200900 Cabinet Base (W) 24 (H) 2 (D) 13 1/2 |  200900 Cabinet Base (W) 32 (H) 2 (D) 13 1/2 |
|  200101 Open Cabinet (W) 16 (H) 26 (D) 19 1/2 |  200104 Open Cabinet (W) 20 (H) 26 (D) 19 1/2 |  200107 Open Cabinet (W) 24 (H) 26 (D) 19 1/2 |  200110 Open Cabinet (W) 32 (H) 26 (D) 19 1/2 |
|  200900 Cabinet Base (W) 16 (H) 2 (D) 19 1/2 |  200900 Cabinet Base (W) 20 (H) 2 (D) 19 1/2 |  200900 Cabinet Base (W) 24 (H) 2 (D) 19 1/2 |  200900 Cabinet Base (W) 32 (H) 2 (D) 19 1/2 |

DOORS

Single doors shown hinged right.

| | | | | | |
|--|---|--|--|---|---|
|  200806 (Base) Single Door 16"W x 25 1/4"H x 3/4"D |  200807 (Wall) Single Door 16"W x 25 1/4"H x 3/4"D |  200806 (Base) Single Door 20"W x 25 1/4"H x 3/4"D |  200807 (Wall) Single Door 20"W x 25 1/4"H x 3/4"D |  200812 (Base) Double Doors 24"W x 25 1/4"H x 3/4"D |  200812 (Base) Double Doors 32"W x 25 1/4"H x 3/4"D |
|  200806 (Base) Single Door 16"W x 37 1/4"H x 3/4"D |  200807 (Wall) Single Door 16"W x 37 1/4"H x 3/4"D |  200806 (Base) Single Door 20"W x 37 1/4"H x 3/4"D |  200807 (Wall) Single Door 20"W x 37 1/4"H x 3/4"D |  200812 (Base) Double Doors 24"W x 37 1/4"H x 3/4"D |  200812 (Base) Double Doors 32"W x 37 1/4"H x 3/4"D |

GLASS DOORS

| | | | | | | | |
|---|--|---|---|--|--|--|--|
|  200835 (Clear) Single Glass Door 16"W x 12 1/2"H x 3/4"D |  200823 (Frosted) Single Glass Door 16"W x 12 1/2"H x 3/4"D |  200841 (Clear) Single Glass Door 20"W x 12 1/2"H x 3/4"D |  200829 (Frosted) Single Glass Door 20"W x 12 1/2"H x 3/4"D |  200832 (Clear) Double Glass Doors 24"W x 12 1/2"H x 3/4"D |  200820 (Frosted) Double Glass Doors 24"W x 12 1/2"H x 3/4"D |  200838 (Clear) Double Glass Doors 32"W x 12 1/2"H x 3/4"D |  200826 (Frosted) Double Glass Doors 32"W x 12 1/2"H x 3/4"D |
|  200836 (Clear) Single Glass Door 16"W x 25 1/4"H x 3/4"D |  200824 (Frosted) Single Glass Door 16"W x 25 1/4"H x 3/4"D |  200842 (Clear) Single Glass Door 20"W x 25 1/4"H x 3/4"D |  200830 (Frosted) Single Glass Door 20"W x 25 1/4"H x 3/4"D |  200833 (Clear) Double Glass Doors 24"W x 25 1/4"H x 3/4"D |  200821 (Frosted) Double Glass Doors 24"W x 25 1/4"H x 3/4"D |  200839 (Clear) Double Glass Doors 32"W x 25 1/4"H x 3/4"D |  200827 (Frosted) Double Glass Doors 32"W x 25 1/4"H x 3/4"D |
|  200837 (Clear) Single Glass Door 16"W x 37 1/4"H x 3/4"D |  200825 (Frosted) Single Glass Door 16"W x 37 1/4"H x 3/4"D |  200843 (Clear) Single Glass Door 20"W x 37 1/4"H x 3/4"D |  200831 (Frosted) Single Glass Door 20"W x 37 1/4"H x 3/4"D |  200834 (Clear) Double Glass Doors 24"W x 37 1/4"H x 3/4"D |  200822 (Frosted) Double Glass Doors 24"W x 37 1/4"H x 3/4"D |  200840 (Clear) Double Glass Doors 32"W x 37 1/4"H x 3/4"D |  200828 (Frosted) Double Glass Doors 32"W x 37 1/4"H x 3/4"D |

DRAWERS

























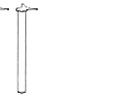



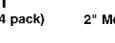

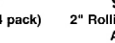
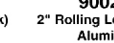

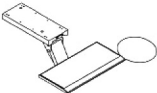
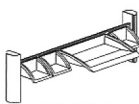
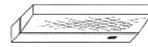

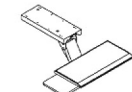





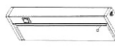



| | | |
|---|---|---|
|  200816 6"H Drawer, 6-6 (W) 16 (H) 12 1/2 (D) 18 3/4 |  200817 8"H Drawer, 8-8-8 (W) 16 (H) 25 (D) 18 3/4 |  200818 12"H Drawer, 12 (W) 16 (H) 12 1/2 (D) 18 3/4 |
|  200816 6"H Drawer, 6-6 (W) 20 (H) 12 1/2 (D) 18 3/4 |  200817 8"H Drawer, 8-8-8 (W) 20 (H) 25 (D) 18 3/4 |  200818 12"H Drawer, 12 (W) 20 (H) 12 1/2 (D) 18 3/4 |
|  200816 6"H Drawer, 6-6 (W) 24 (H) 12 1/2 (D) 18 3/4 |  200817 8"H Drawer, 8-8-8 (W) 24 (H) 25 (D) 18 3/4 |  200818 12"H Drawer, 12 (W) 24 (H) 12 1/2 (D) 18 3/4 |
|  200816 6"H Drawer, 6-6 (W) 32 (H) 12 1/2 (D) 18 3/4 |  200817 8"H Drawer, 8-8-8 (W) 32 (H) 25 (D) 18 3/4 |  200818 12"H Drawer, 12 (W) 32 (H) 12 1/2 (D) 18 3/4 |

TABLE AND LEGS

| | | | | | | |
|---|--|---|---|---|---|--|
|  900212 6"W 27 1/8"H 6"D 6" Cylinder Base - Pewter |  200720 Round Table Top (W) 36 42 48 (H) 1 1/2 |  900200 2"W 27 1/8"H 2"D 2" Metal Leg (4 pack) Pewter |  900202 2"W 27 1/8"H 2"D 2" Metal Leg (4 pack) Satin Chrome |  900208 2"W 27 1/8"H 2"D 2" Rolling Leg (4 pack) Pewter |  900210 2"W 27 1/8"H 2"D 2" Rolling Leg (4 pack) Satin Chrome |  900215 27"W 27 1/8"H 27"D Pedestal Base Black |
|  900213 6" Cylinder Base - Black | |  900201 2" Metal Leg (4 pack) Black |  900203 2" Metal Leg (4 pack) Aluminum |  900209 2" Rolling Leg (4 pack) Black |  900211 2" Rolling Leg (4 pack) Aluminum | |

ACCESSORIES

Please refer to *Accessories Workbook* for more information.

| | | | | |
|--|--|---|--|---|
|  900006 Curved Strap Pull Satin Chrome |  900400 29"W 5"H 10"D Keyboard Mechanism Black |  900405 34"W 10"H Desktop Organizer w/Trays Aluminum |  900600 18"W 1 1/2"H 6 1/2"D 18" Fluorescent Task Light Black |  200870 CD Drawer - Wood (pulls included) |
|  900007 Curved Triline Pull Satin Chrome |  900401 29"W 5"H 10"D Keyboard Mechanism Black |  900406 16"W 1"H 8"D Corner Sleeve Black |  900601 30"W 1 1/2"H 6 1/2"D 30" Fluorescent Task Light Black |  200872 CD Drawer - Metal |
|  900008 Curved Wide Ellipse Pull Satin Chrome |  900402 21"W 3/4"H 11"D 21" Keyboard Tray |  900407 8"W 15"H 6"D CPU Holder Black |  900602 6"W 1 1/2"H 3 1/2"D Single Halogen Task Light Black |  200871 Paper Drawer - Wood (pulls included) |
|  900009 Eyelid Pull Satin Chrome |  900408 28"W 3/4"H 11"D 28" Keyboard Tray |  900408 9"W 9"H 20"D CPU Trolley Black |  900603 12"W 1 1/2"H 3 1/2"D Double Halogen Task Light Black |  200873 Paper Drawer - Metal |
|  900011 Standard Pull Satin Chrome |  900012 Standard Pull Black |  900813 Caster Pack (4/pack) |  900604 1"W 7"H 9"D Bookcase Lights (set of 3) Aluminum | |
|  900013 Standard Pull Antique White |  900014 Standard Pull Arctic White | | | |
|  900015 Curved Pull Black |  900016 Curved Pull Pewter | | | |

TQS LAMINATE FINISHES

Series 2 TQS is offered in our most popular wood grain finishes – Kensington Maple, Honey Maple, American Cherry and Cocoa Maple.

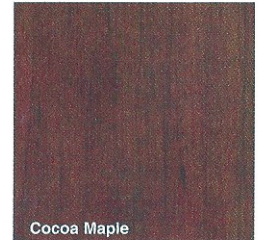
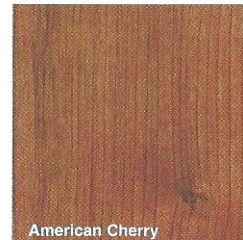
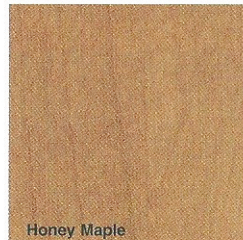
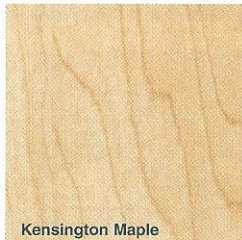

TQS techline Quick Ship

Series 2

TECHLINE'S SERIES 2 QUICK SHIP PROGRAM OR TQS CONSISTS OF OUR TOP-SELLING ITEMS IN FOUR DIFFERENT FINISHES READY FOR IMMEDIATE SHIPMENT.

In Stock

TQS is manufactured exclusively in Waunakee, WI and can be shipped immediately to our authorized dealers

Top Sellers

TQS includes our most popular office and storage items

Four Finishes

TQS is available in four wood grain finishes – Kensington Maple, Honey Maple, American Cherry and Cocoa Maple

Modular Alignment

TQS can be put in a desk, hutch and bookcase in perfect Alignment and includes wall-mounted cabinets for Extra storage

Configuration Ideas

20 popular office configuration ideas shown below fit a Variety of spaces

Accessories

TQS accessories allow you to personalize your office

